

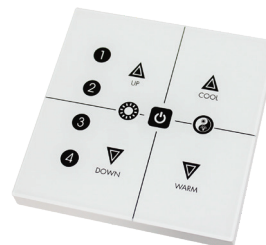











Product Description

A wall-mounted touch panel designed to operate with Hytronik range of Bluetooth products. It supports Human Centric lighting to provide elegant control of circadian rhythm profiles to suit office, education and healthcare applications. 6 programmable scene are provided, as well as brightness and tunable white control. The HBPO1 is programmable using **Koolmesh™** app.











App Features

-  Grouping luminaires via mesh network
 - Two levels: room & group
 - Synchronization control
-  7 types of scene options to set up*
 - Generic Scenes
 - Lux ON/OFF Scenes
 - Daylight Harvest (Open loop)
 - Daylight Harvest (Closed loop)
 - Circadian Rhythm (With daylight sensor)
 - Circadian Rhythm (Without daylight sensor)
 - Time-based Scene
-  Schedule to run scenes based on time and date
-  Astro timer (sunrise and sunset)
-  Floorplan feature to simplify project planning
-  Offline commissioning
-  Different permission levels via authority management
-  Network sharing via QR code or keycode
-  Remote control via gateway support HBGW01
-  Interoperability with Hytronik Bluetooth product portfolio
-  Device firmware update over-the-air (OTA)
-  Continuous development in progress...

* Certain scenes which require external photocell can be achieved by using together with Hytronik Bluetooth sensors, such as HBIR29, HCD038/BT + sensor head etc.

Hardware Features

-  Mains powered
-  Designed for electrical box/junction box
-  Keep real time for up to 7-8 weeks against power failure
-  Manual adjustment: on/off, dim and color tuning
-  Manual/Auto display screen brightness adjustment
-  Touch screen with vibration/beeper/LED indication
-  Clean mode/Screen lock time
-  5-year warranty

 **Bluetooth 5.0 SIG mesh**



iOS 10.0 or later



Android 5.0 or later







Web app/platform:
iot.koolmesh.com

Technical Specifications

Bluetooth Transceiver	
Operation frequency	2.4 GHz - 2.483 GHz
Transmission power	4 dBm
Range (Typical indoor)	10~30m
Protocol	Bluetooth® 5.0 SIG Mesh
Environment	
Operation temperature	T _a : 0°C ~ +40°C
Relative humidity	20% ~ 90%
IP rating	IP20

Input Characteristics	
Operating voltage	220~240VAC 50/60Hz
Stand-by power	<1W
Safety & EMC	
EMC standard (EMC)	EN55015, EN61000, EN61547
Safety standard (LVD)	EN60669-1/-2-1 AS/NZS60669-1/-2-1
RED	EN300328, EN301489-1/-17
Certification	CB, CE, EMC, RED, RCM

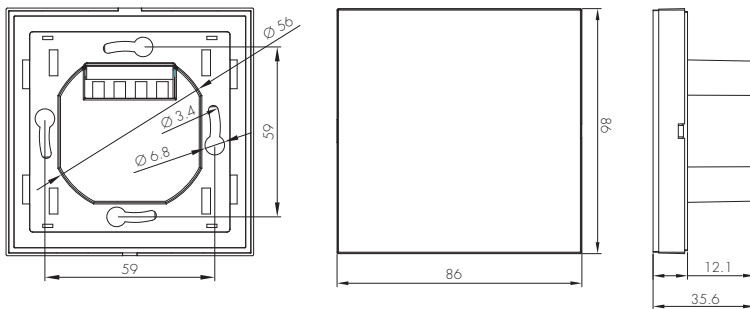
Mechanical Structure & Dimensions



Wiring Diagram

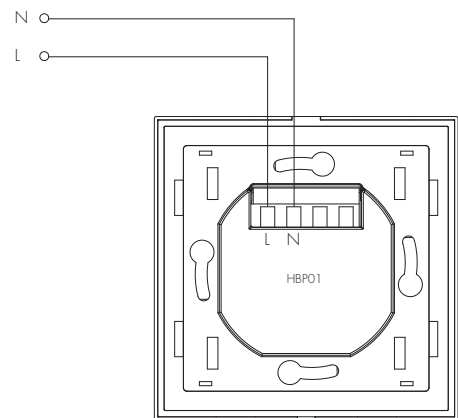

Wire Preparation



Rising clamp terminal.

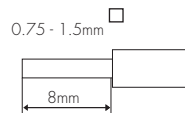

To make or release the wire from the terminal, use a screwdriver to push down the button.

Operation



Scenes are simply programmed using the App.

Create and name the scenes using the scenes menu, and then assign the scenes to buttons ① ② ③ ④ from the device settings menu.

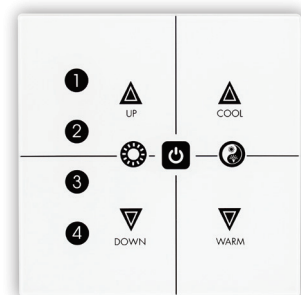



The ON/OFF button has a configurable response via the App.

1) Permanent OFF (Occupancy sensor disabled).

Turning off via the ON/OFF button will suspend the entire system, including occupancy sensor. Pressing this button again will resume the last automatic profile selected, or pressing any other button on the control panel will wake up the system.

2) Clean Mode

Long press this button for more than 5s to go to clean mode (during this clean mode, the touch panel screen will be locked and does not respond to any touch), it will quit automatically after 1 min.

Touch Indications

Three methods for successful touch indications:

Vibration / Beeper / LED indicator

User can select any one, two or all of them to indicate successful touch on HBPO1 in the App.

Real-time Sustainability

The touch panel HBPO1 can keep the time running for up to 7-8 weeks against power failure.

Additional Information / Documents

1. To learn more about detailed product features/functions, please refer to [www.hytronik.com/download->knowledge->Introduction of App Scenes and Product Functions](http://www.hytronik.com/download->knowledge->Introduction%20of%20App%20Scenes%20and%20Product%20Functions)
2. Regarding precautions for Bluetooth product installation and operation, please kindly refer to [www.hytronik.com/download/knowledge->Bluetooth Products - Precautions for Product Installation and Operation](http://www.hytronik.com/download/knowledge->Bluetooth%20Products%20-%20Precautions%20for%20Product%20Installation%20and%20Operation)
3. Data sheet is subject to change without notice. Please always refer to the most recent release on [www.hytronik.com/products/bluetooth technology ->Bluetooth Accessories](http://www.hytronik.com/products/bluetooth%20technology->Bluetooth%20Accessories)
4. Regarding Hytronik standard guarantee policy, please refer to [www.hytronik.com/download/knowledge->Hytronik Standard Guarantee Policy](http://www.hytronik.com/download/knowledge->Hytronik%20Standard%20Guarantee%20Policy)